

Product Specifications

Industrial DIN-rail L3 Multi-port Ring Managed Switch Series

IGS-6325-8UP2S2X

IGS-6325-8UP2S

Version 1.0

This document contains confidential proprietary information and is property of PLANET. The contents of this document should not be disclosed to unauthorized persons without the written consent of PLANET.

Change History:

Revision	Date	Author	Change List
1.0	2019/12/05	Calvin Chao	Initial release

Author	Calvin Chao	Editor:	
Reviewed by:	Mark Kao	Approved by:	Kent Kang

1. PRODUCT DESCRIPTION

Outstanding 802.3bt PoE++ Solution for Hardened Environment

Complying with the IEEE 802.3bt Power over Ethernet Plus Plus technology, PLANET IGS-6325-8UP2S2X and IGS-6325-8UP2S L3 Industrial Managed PoE++ Switch series features **eight 10/100/1000BASE-T 802.3bt PoE++ ports** with each port powering up to **95 watts**, **two 100/1000BASE-X SFP** and up to **two 10G SFP+ ports** interfaces in a rugged IP30 metal case for stable operation in heavy industrial demanding environments. It supports rich PoE operation modes including **90-watt 802.3bt type-4 PoE++ ports**, **95-watt PoH** (Power over HD-BASE-T) mode and 4-pair **force mode** to solve the incompatibility of non-standard 4-pair PoE PDs in the field.

Models	10/100/1000T 802.3bt PoE++ Port	100/1000X SFP	1G/10G SFP+	PoE Budget	Power Input
IGS-6325-8UP2S2X	8	2	2	360 watts	DC 48~56V
IGS-6325-8UP2S			--		

Being able to operate under wide temperature range from -40 to 75 degrees C, the IGS-6325 PoE++ Switch series can be placed in almost any difficult environment. The IGS-6325 PoE++ Switch series also allows either DIN rail or wall mounting for efficient use of cabinet space.

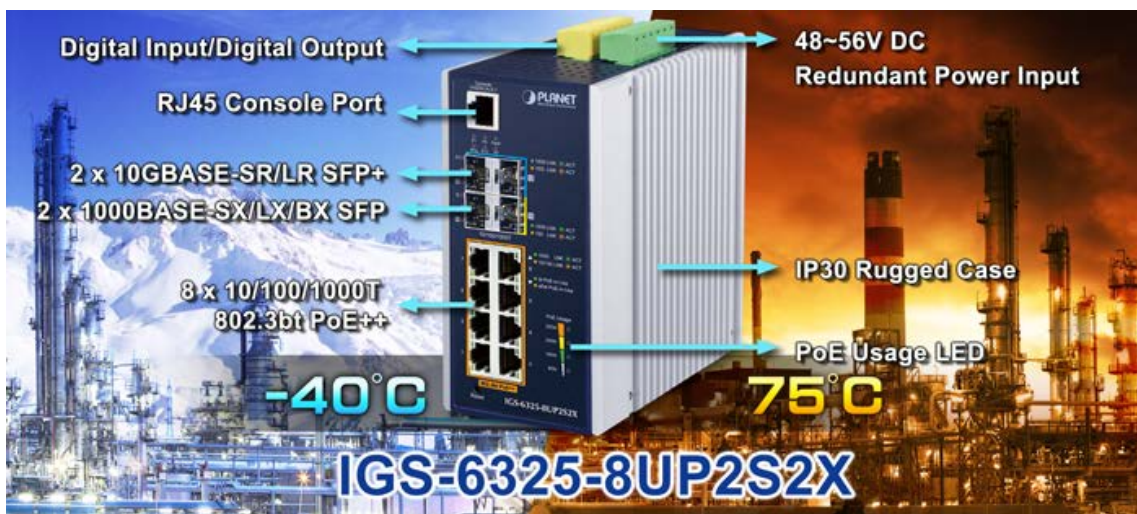

802.3bt PoE++ – 90~95-watt Power over 4-pair UTP Solution

As the IGS-6325 PoE++ Series adopts the IEEE 802.3bt PoE++ standard and PoH technology, it is capable to source up to **95 watts** of power by using all the four pairs of standard Cat5e/6 Ethernet cabling to deliver power and full-speed data to each remote PoE compliant powered device (PD). It possesses triple amount of power capability than the conventional 802.3at PoE+ and is an ideal solution to satisfy the growing demand for higher power consuming network PDs, such as:

- PoE PTZ speed dome cameras
- Network devices
- Thin clients
- AIO (all-in-one) touch PCs, point of sale (POS) and information kiosks
- Remote digital signage displays

■ PoE lightings

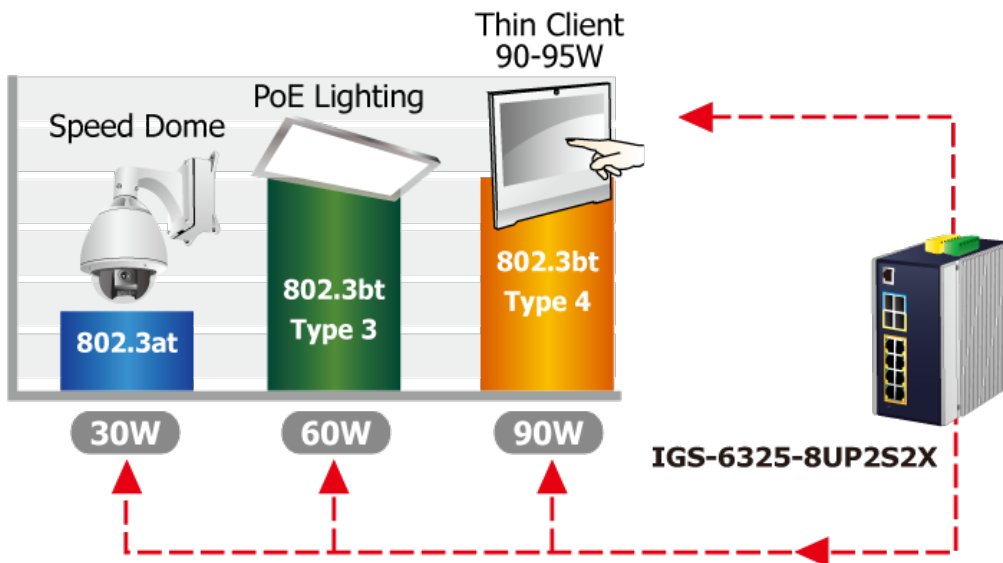

802.3bt PoE++ and Advanced PoE Power Output Mode Management

To meet the demand of various powered devices consuming stable PoE power, the IGS-6325 PoE++ Switch series provides five different PoE power output modes for selection.

- 90W 802.3bt PoE++ Power Output Mode
- 95W UPOE/PoH Power Output Mode
- 60W Force Power Output Mode
- 30W End-span PoE Power Output Mode
- 30W Mid-span PoE Power Output Mode

Convenient and Smart ONVIF Devices with Detection Feature

PLANET has newly developed an awesome feature -- ONVIF Support -- which is specifically designed for co-operating with video IP surveillances. From the IGS-6325 PoE++ Switch series GUI, clients just need one click to search and show all of the ONVIF devices via network application.

In addition, clients can upload floor plans to the switch, allowing to locate surveillance devices for easier inspection and planning. Moreover, clients can get real-time surveillance's information and online/offline status, and also allows cameras PoE reboot control from GUI.

Intelligent Alive Check for Powered Device

The IGS-6325 PoE++ Series can be configured to monitor connected PD's status in real time via ping action. Once the PD stops working and responding, the IGS-6325 PoE++ Series will recycle the PoE port power and bring the PD back to work. It also greatly enhances the reliability in that the PoE port will reset the PD power, thus reducing administrator's management burden.

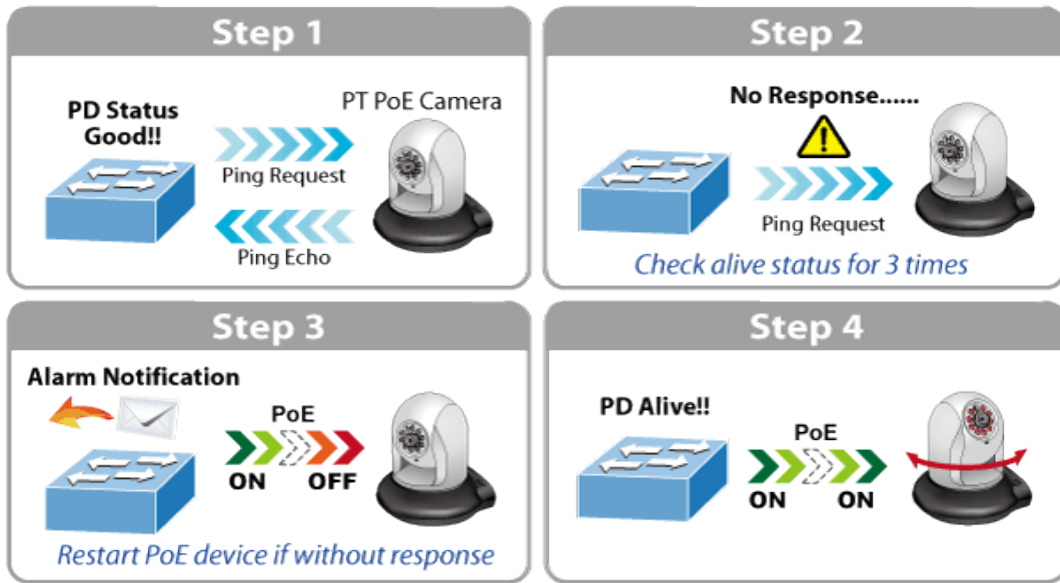

PoE Schedule for Energy Saving

Under the trend of energy saving worldwide and contributing to environmental protection on the Earth, the IGS-6325 PoE++ Series can effectively control the power supply besides its capability of giving high watts power. The built-in “**PoE schedule**” function helps you to enable or disable PoE power feeding for each PoE port during specified time intervals and it is a powerful function to help SMBs or enterprises save power and money.

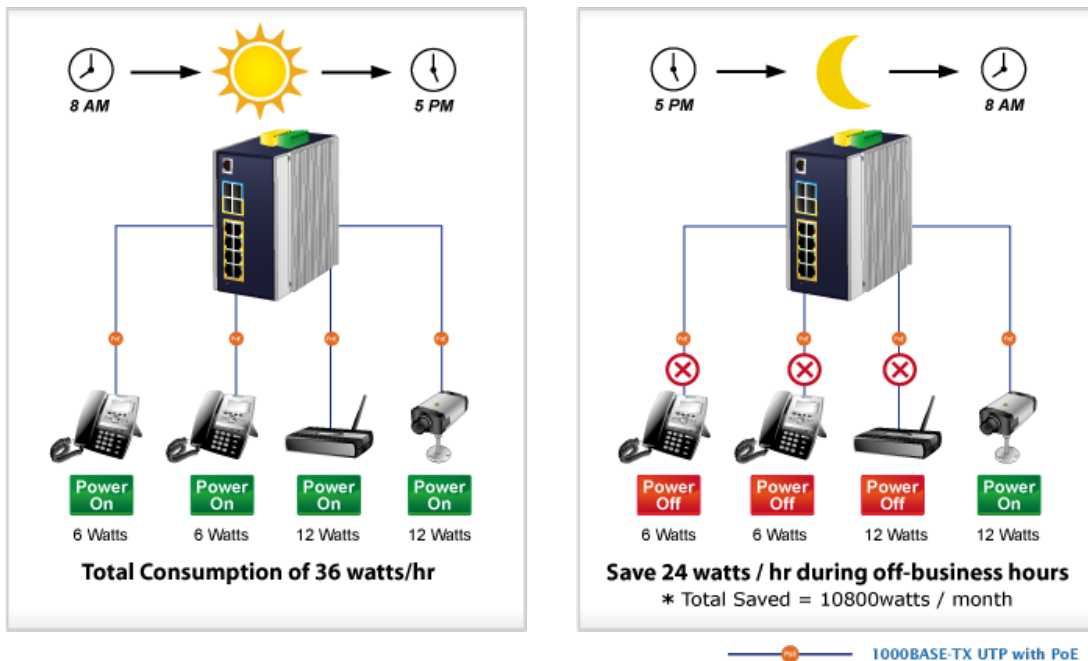

Scheduled Power Recycling

The IGS-6325 PoE++ Series allows each of the connected PoE IP cameras or PoE wireless access points to reboot at a specific time each week. Therefore, it will reduce the chance of IP camera or AP crash resulting from buffer overflow.

Layer 3 Routing Support

The IGS-6325 Series enables the administrator to conveniently boost network efficiency by configuring Layer 3 IPv4/IPv6 VLAN static routing manually, and the IPv4 **OSPFv2** (Open Shortest Path First) settings automatically. The OSPF is an interior dynamic routing protocol for autonomous system based on link state. The protocol creates a database for link state by exchanging link states among Layer 3 switches, and then uses the Shortest Path First algorithm to generate a route table based on that database.

Redundant Ring, Fast Recovery for Critical Network Applications

The IGS-6325 Series supports redundant ring technology and features strong, rapid self-recovery capability to prevent interruptions and external intrusions. It incorporates advanced **ITU-T G.8032 ERPS (Ethernet Ring Protection Switching)** technology, Spanning Tree Protocol (802.1s MSTP), and **redundant power** input system into customer's industrial automation network to enhance system reliability and uptime in harsh factory environments. In a certain simple Ring network, the recovery time of data link can be as fast as 10ms.

ERPS Ring for Video Transmission Redundancy

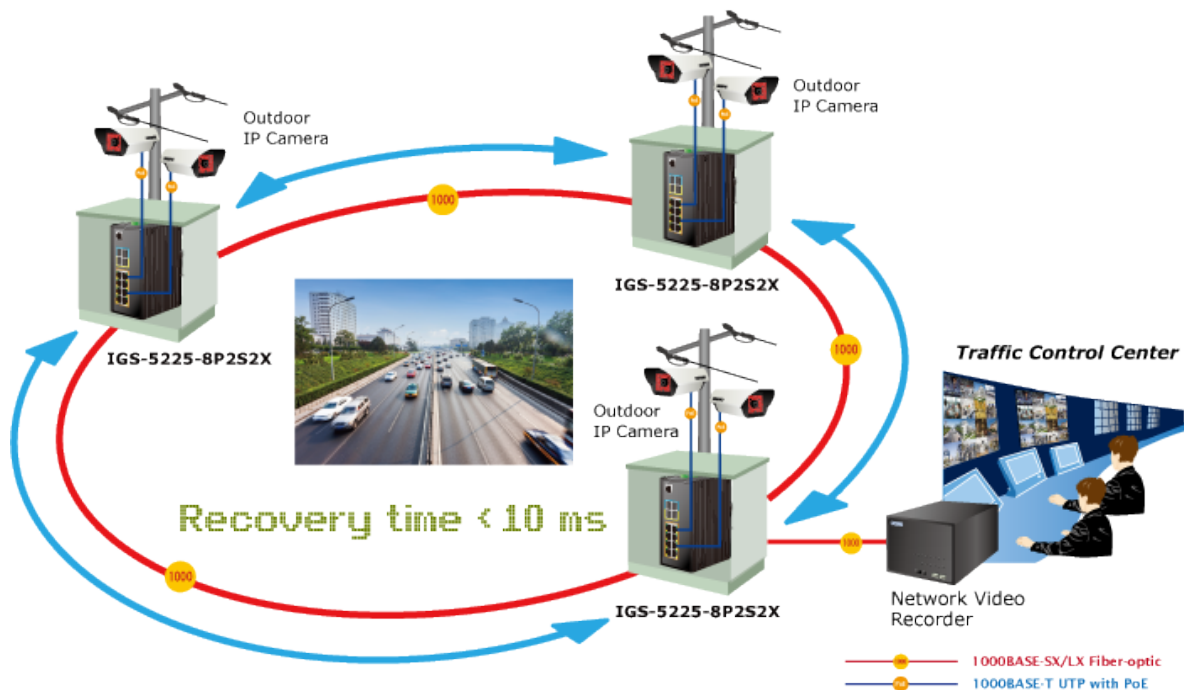

Network with Cybersecurity Helps Minimize Security Risks

The IGS-6325 Series comes with enhanced cybersecurity to fend off cyberthreats and cyberattacks. It supports SSHv2, TLS and SSL protocols to provide strong protection against advanced threats. Served as a key point to transmit data and offering over 95-watt PoE output to customer's critical equipment in a business network, the cybersecurity feature of the IGS-6325 Series protects the switch management and enhances the security of the mission-critical network without any extra deployment cost and effort.

Modbus TCP Provides Flexible Network Connectivity for Factory Automation

With the supported **Modbus TCP/IP** protocol, the IGS-6325 Series can easily integrate with **SCADA** systems, **HMI** systems and other data acquisition systems in factory floors. It enables administrators to remotely monitor the industrial Ethernet switch's **operating information, port information**, communication status, and DI and DO status, thus easily achieving enhanced monitoring and maintenance of the entire factory.

1588 Time Protocol for Industrial Computing Networks

The IGS-6325 Series is ideal for telecom and Carrier Ethernet applications, supporting MEF service delivery and timing over packet solutions for IEEE 1588 and synchronous Ethernet.

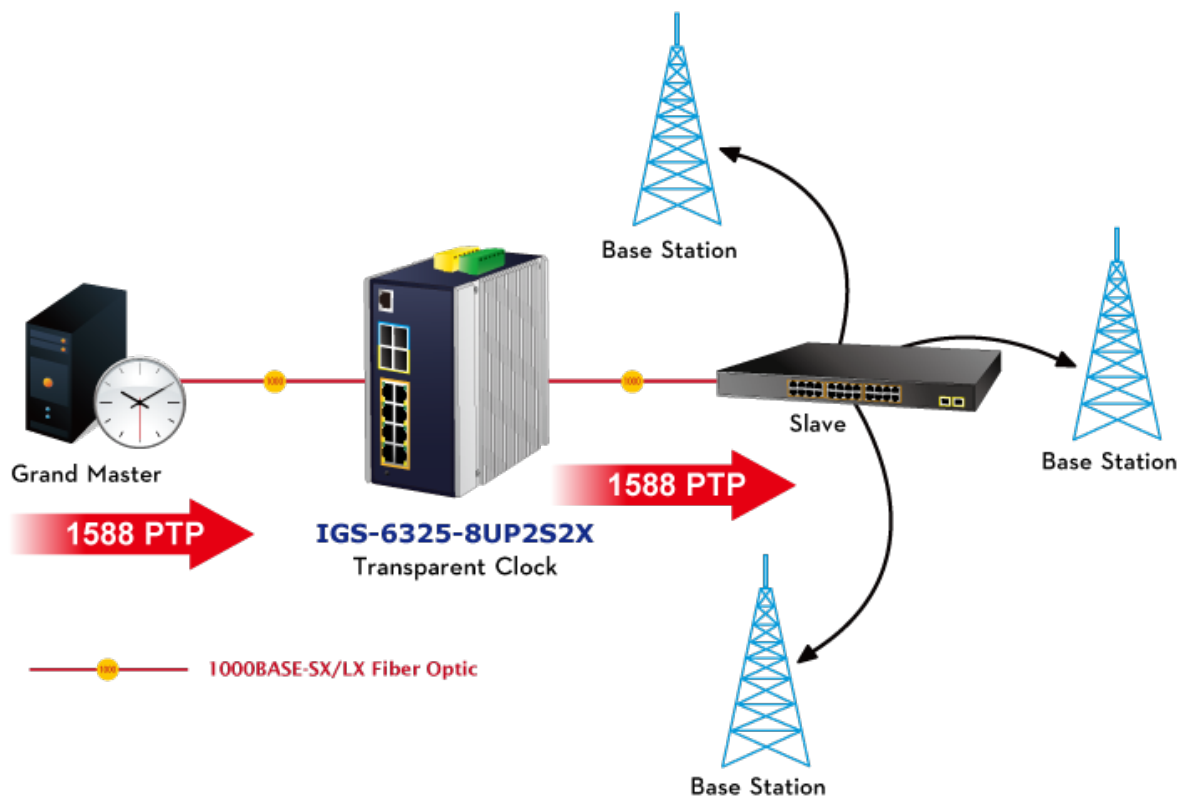

SMTP/SNMP Trap Event Alert

The IGS-6325 Series provides event alert function to help to diagnose the abnormal device owing to whether or not there is a break of the network connection, or the rebooting response.

SMTP/SNMP Trap Event Alert

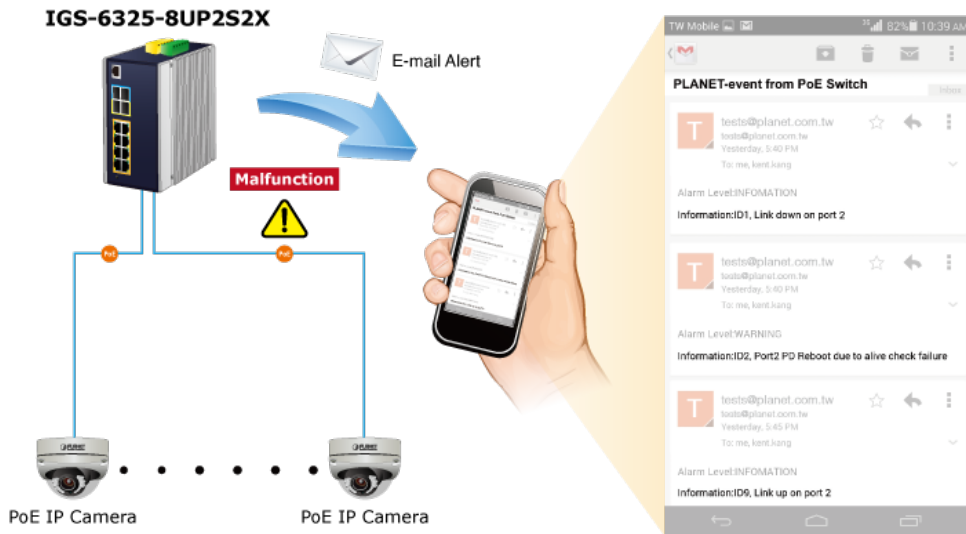

Effective Alarm Alert for Better Protection

The IGS-6325 Series supports a Fault Alarm feature which can alert the users when there is something wrong with the switches. With this ideal feature, the users would not have to waste time finding where the problem is. It will help to save time and human resource.

Fault Alarm Feature

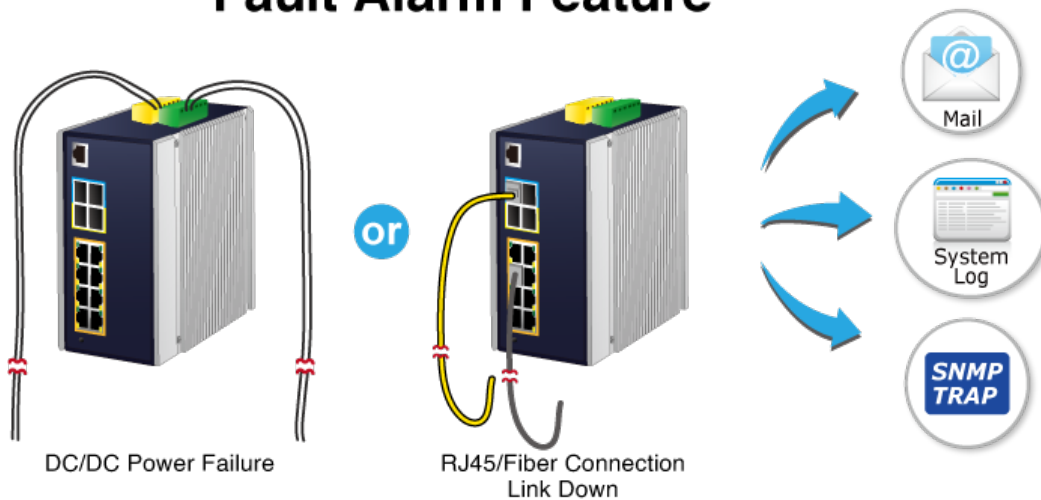

Digital Input and Digital Output for External Alarm

The IGS-6325 Series supports Digital Input and Digital Output on its front panel. This external alarm enables users to use Digital Input to detect and log external device status (such as door intrusion detector), and send event alarm to the administrators. The Digital Output could be used to alarm the administrators if the IGS-6325 Series' port shows link down, link up or power failure.

Digital Input

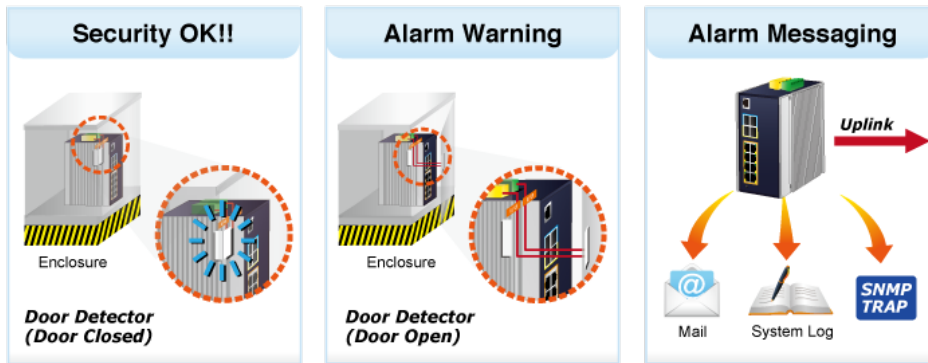

Digital Output

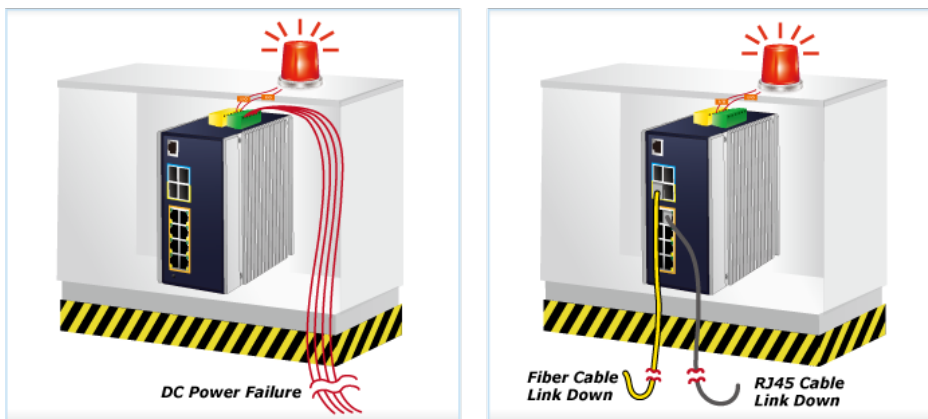

Robust Layer 2 Features

The IGS-6325 Series can be programmed for advanced Layer 2 switch management functions such as dynamic port link aggregation, 802.1Q tagged VLAN, Q-in-Q VLAN, private VLAN, Multiple Spanning Tree Protocol (MSTP), Layer 2 to Layer 4 QoS, bandwidth control, IGMP snooping and MLD snooping. Via the aggregation of supporting ports, the IGS-6325 Series allows the operation of a high-speed trunk group that comes with multiple ports and supports fail-over as well.

Efficient Management

For efficient management, the IGS-6325 Series is equipped with console, Web and SNMP management interfaces.

- With the built-in **Web-based** management interface, it offers an easy-to-use, platform-independent management and configuration facility.
- For **text-based** management, it can be accessed via Telnet and the console port.
- For standard-based monitor and management software, it offers SNMPv3 connection which encrypts the packet content at each session for secure remote management.

Powerful Network Security

The IGS-6325 Series offers comprehensive Layer 2 to Layer 4 **Access Control List (ACL)** for enforcing security to the edge. It can be used to restrict network access by denying packets based on source and destination IP address, TCP/UDP ports or defined typical network applications. Its protection mechanism also comprises **802.1X Port-based** and **MAC-based** user and device authentication. With the **private VLAN** function, communication between edge ports can be prevented to ensure user privacy.

Advanced IP Network Protection

The IGS-6325 Series also provides **DHCP Snooping**, **IP Source Guard** and **Dynamic ARP Inspection** functions to prevent IP snooping from attack and discard ARP packets with invalid MAC address. The network administrators can now construct highly-secure corporate networks with considerably less time and effort than before.

Flexible and Extendable 10Gb Ethernet Solution

10G Ethernet is a big leap in the evolution of Ethernet. Each of the 10G SFP+ slots in the IGS-6325-8UP2S2X supports **dual speed** and **10GBASE-SR/LR** or **1000BASE-SX/LX**. With its 2-port, 10G Ethernet link capability and additional 2-port 1G Ethernet link capability, the administrator now can flexibly choose the suitable SFP/SFP+ transceiver according to the transmission distance or the transmission speed required to extend the network efficiently. The IGS-6325-8UP2S2X provides broad bandwidth and powerful processing capacity.

Intelligent SFP Diagnosis Mechanism

The IGS-6325 Series supports SFP-DDM (digital diagnostic monitor) function that greatly helps network administrator to easily monitor real-time parameters of the SFP and SFP+ transceivers, such as optical output power, optical input power, temperature, laser bias current, and transceiver supply voltage.

Digital Diagnostic Monitor (DDM)

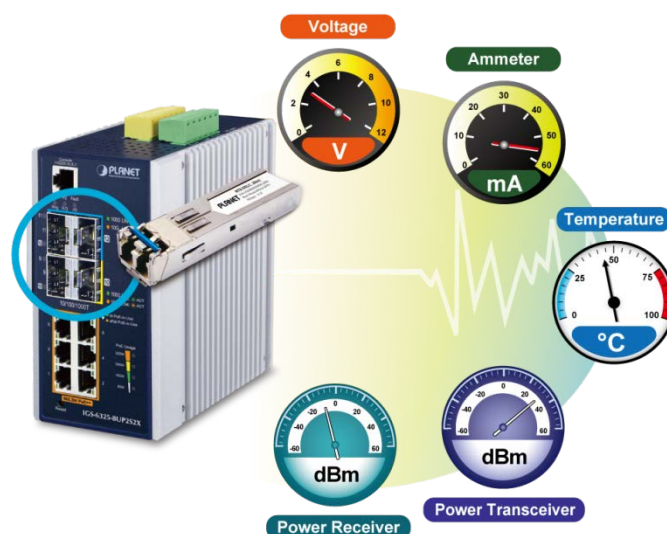

2. PRODUCT FEATURES

➤ **Physical Port**

- 8 10/100/1000BASE-T Gigabit Ethernet RJ45 ports with 802.3bt PoE++ Injector function
- 2 100/1000BASE-X SFP slots for SFP type auto detection
- 2 10GBASE-SR/LR SFP+ slots, compatible with 1000BASE-X SFP(IGS-6325-8UP2S2X)
- One RJ45-to-RS232 console interface for basic management and setup

➤ **Industrial Hardened-design**

- Dual power input, redundant power with reverse polarity protection
 - DC 48 to 56V input
 - Active-active redundant power failure protection
 - Backup of catastrophic power failure on one supply
 - Fault tolerance and resilience
- DIN-rail and wall-mountable design
- IP30 aluminum case
- Supports 6000V DC Ethernet ESD protection
- -40 to 75 degrees C operating temperature

➤ **Digital Input and Digital Output**

- 2 Digital Input (DI)
- 2 Digital Output (DO)
- Integrate sensors into auto alarm system
- Transfer alarm to IP network via email and SNMP trap

➤ **Power over Ethernet**

- Complies with IEEE 802.3bt Power over Ethernet Plus Plus Type 4 PSE
- Backward compatible with IEEE 802.3at/af PD device
- Up to 8 ports of IEEE 802.3af/IEEE 802.3at/IEEE 802.3bt PoE++ devices powered
- Supports PoE power up to 95 watts for each PoE port
- Total of 360-watt PoE budget
- Auto detects powered device (PD)
- Circuit protection prevents power interference between ports
- Remote power feeding up to 100m
- PoE management features
 - Total PoE power budget control
 - Per port PoE function enable/disable
 - PoE admin-mode control
 - PoE port power feeding priority
 - Per PoE port power limit
 - PD classification detection
 - PoE extend mode control to support power feeding up to a distance of up to 160 meters
- Intelligent PoE features

- Temperature threshold control
- PoE usage threshold control
- PD alive check
- PoE schedule

➤ **Layer 3 IP Routing Features**

- IP dynamic routing protocol supports OSPFv2
- IPv4/IPv6 hardware static routing
- Routing interface provides per VLAN routing mode

➤ **Layer 2 Features**

- High performance of Store-and-Forward architecture, and runt/CRC filtering eliminates erroneous packets to optimize the network bandwidth
- Storm Control support
 - Broadcast/Multicast/Unicast
- Supports VLAN
 - IEEE 802.1Q tagged VLAN
 - Up to 255 VLANs groups, out of 4095 VLAN IDs
 - Supports provider bridging (VLAN Q-in-Q IEEE 802.1ad)
 - Private VLAN Edge (PVE)
 - Protocol-based VLAN
 - MAC-based VLAN
 - Voice VLAN
 - GVRP (GARP VLAN Registration Protocol)
- Supports Spanning Tree Protocol
 - IEEE 802.1D Spanning Tree Protocol (STP)
 - IEEE 802.1w Rapid Spanning Tree Protocol (RSTP)
 - IEEE 802.1s Multiple Spanning Tree Protocol (MSTP), spanning tree by VLAN
 - BPDU Guard
- Supports Link Aggregation
 - 802.3ad Link Aggregation Control Protocol (LACP)
 - Cisco ether-channel (static trunk)
 - Maximum 4 trunk groups with 4 ports per trunk group
 - Up to 40Gbps bandwidth (duplex mode)
- Provides port mirror (many-to-1)
- Port mirroring to monitor the incoming or outgoing traffic on a particular port
- Loop protection to avoid broadcast loops
- Link Layer Discovery Protocol (LLDP)
- Compatible with Cisco uni-directional link detection(UDLD) that monitors a link between two switches and blocks the ports on both ends of the link if the link fails at any point between the two devices
- Supports G.8032 ERPS (Ethernet Ring Protection Switching)
- IEEE 1588 and Synchronous Ethernet network timing

➤ **Quality of Service**

- Ingress Shaper and Egress Rate Limit per port bandwidth control
- 8 priority queues on all switch ports
- Traffic classification
 - IEEE 802.1p CoS
 - IP TOS/DSCP/IP precedence
 - IP TCP/UDP port number
 - Typical network application
- Strict priority and Weighted Round Robin (WRR) CoS policies
- Supports QoS and In/Out bandwidth control on each port
- Traffic-policing on the switch port
- DSCP remarking

➤ **Multicast**

- Supports IPv4 IGMP snooping v1, v2 and v3
- Supports IPv6 MLD snooping v1 and v2
- Querier mode support
- IPv4 IGMP snooping port filtering
- IPv6 MLD snooping port filtering
- MVR (Multicast VLAN Registration)

➤ **Security**

- Authentication
 - IEEE 802.1X Port-based/MAC-based network access authentication
 - Built-in RADIUS client to cooperate with the RADIUS servers
 - TACACS+ login users access authentication
 - RADIUS/TACACS+ users access authentication
 - Guest VLAN assigns clients to a restricted VLAN with limited services.
- Access Control List
 - IP-based Access Control List (ACL)
 - MAC-based Access Control List
- Source MAC/IP address binding
- DHCP snooping to filter distrusted DHCP messages
- Dynamic ARP Inspection discards ARP packets with invalid MAC address to IP address binding
- IP Source Guard prevents IP spoofing attacks
- IP address access management to prevent unauthorized intruder

➤ **Management**

- IPv4 and IPv6 dual stack management
- Switch Management Interfaces
 - Console and Telnet Command Line Interface
 - HTTP web switch management

- SNMP v1 and v2c switch management
- SSH, TLS, SSL and SNMP v3 secure access
- SNMP Management
 - Four RMON groups (history, statistics, alarms, and events)
 - SNMP trap for interface Link Up and Link Down notification
- IPv6 IP address/NTP/DNS management
- Built-in Trivial File Transfer Protocol (TFTP) client
- BOOTP and DHCP for IP address assignment
- System Maintenance
 - Firmware upload/download via HTTP
 - Reset button for system reboot or reset to factory default
 - Dual images
- DHCP Relay
- DHCP Option 82
- DHCP Server
- User Privilege levels control
- Network Time Protocol (NTP)
- Network Diagnostic
 - SFP-DDM (Digital Diagnostic Monitor)
 - Cable diagnostic technology provides the mechanism to detect and report potential cabling issues
 - ICMPv6/ICMPv4 remote ping
- SMTP/Syslog remote alarm
- System Log
- PLANET Smart Discovery Utility for deployment management

3. PRODUCT SPECIFICATIONS

3.1 MAIN COMPONENTS

Models	IGS-6325-8UP2S	IGS-6325-8UP2S2X
Switch ASIC	Microchip VSC7442	Microchip VSC7444
CPU	500MHz MIPS 24KEc CPU (integrated with VSC7442/VSC7444)	
Gigabit PHY	Microchip VSC8514XMK-14 x 2	
PoE Controller	Microchip PD69200C_v3.49 x 1	
PoE PSE IC	Microchip PD69208T4 x 2	
Flash Size	64M bytes	
DRAM Size	512Mbytes	

3.2 FUNCTION SPECIFICATIONS

Product	IGS-6325-8UP2S	IGS-6325-8UP2S2X
Hardware Specifications		
Copper Ports	8 10/100/1000BASE-T RJ45 auto-MDI/MDI-X ports	
SFP Ports	2 1000BASE-SX/LX/BX SFP slot interfaces (Port-9 and Port-10) Compatible with 100BASE-FX SFP	
SFP+ Ports	--	2 10GbBASE-SR/LR SFP+ slot interfaces (Port-11 to Port-12)
PoE Injector Ports	8 ports with 802.3bt PoE++ injector function with Port-1 to Port-8	
Console	1 x RJ45-to-RS232 serial port (115200, 8, N, 1)	
Switch Architecture	Store-and-Forward	
Switch Fabric	20Gbps/non-blocking	60Gbps/non-blocking
Throughput (packet per second)	14.8Mpps@ 64 bytes packet	44.64Mpps@ 64 bytes packet
Address Table	16K entries, automatic source address learning and aging	
Shared Data Buffer	32Mbits	
Jumbo Frame	10Kbytes	
SDRAM	512Mbytes	
Flash Memory	64Mbytes	
Flow Control	IEEE 802.3x pause frame for full-duplex Back pressure for half-duplex	
Reset Button	< 5 sec: System reboot > 5 sec: Factory default	
Connector	Removable 6-pin terminal block for power input Pin 1/2 for Power 1, Pin 3/4 for fault alarm, Pin 5/6 for Power 2 Removable 6-pin terminal block for DI/DO interface Pin 1/2 for DI 1 & 2, Pin 3/4 for DO 1 & 2, Pin 5/6 for GND	
Alarm	One relay output for power failure. Alarm relay current carry ability: 1A	

	@ 24V DC	
Digital Input (DI)	2 digital input: Level 0: -24~2.1V ($\pm 0.1V$) Level 1: 2.1~24V ($\pm 0.1V$) Input load to 24V DC, 10mA max.	
Digital Output (DO)	2 digital output: Open collector to 24VDC, 100mA	
Enclosure	IP30 aluminum case	
Installation	DIN-rail or wall mounting	
Dimensions (W x D x H)	76 x 107 x 152 mm	
Weight	1,138g	1,152g
Power Requirements	Dual DC 48~56V, 7A max. (>52V DC for 802.3bt PoE++ output recommended)	
Power Consumption	Max. 27 watts/92.13BTU@56V DC input (System on) Max. 395 watts/1,347.80BTU@56V DC input (Full loading with 802.3bt PoE++ function)	Max. 29 watts/98.96BTU@56V DC input (System on) Max. 401 watts/1,368.27BTU@56V DC input (Full loading with 802.3bt PoE++ function)
ESD Protection	6KV DC	
Surge Protection	4KV DC	
LED Indicator	System: Power 1 (Green), Power 2 (Green) Fault Alarm (Red) Ring (Green), Ring Owner (Green) DIDO (Red) Per 10/100/1000T RJ45 PoE++ Port: 1000Mbps LNK/ACT (Green) 10/100Mbps LNK/ACT (Amber) 802.3bt PoE++-in-use x 1 (Green) 802.3at/af PoE-in-use x 1 (Amber) Per SFP Interface: 1000 LNK/ACT (Green) 100 LNK/ACT (Amber) Per SFP+ Port (IGS-6325-8UP2S2X): 10Gbps LNK/ACT (Green) 1Gbps LNK/ACT (Amber) PoE Usage: 80W, 160W, 240W, 320W (Amber)	
Power Over Ethernet		
PoE Standard	IEEE 802.3bt PoE++ Type-4 PSE Backward compatible with 802.3at PoE+ PSE	
PoE Power Supply Type	<ul style="list-style-type: none"> ■ 802.3bt PoE++ ■ UPoE/PoH ■ End-span PoE+ ■ Mid-span PoE+ 	

	<ul style="list-style-type: none"> ■ Force
PoE Power Output	802.3bt PoE++ <ul style="list-style-type: none"> - Per port 52V~56V DC (depending on the power supply), max. 90 watts UPoE(PoH) <ul style="list-style-type: none"> - Per port 52V~56V DC (depending on the power supply), max. 95 watts IEEE 802.3at Standard <ul style="list-style-type: none"> - Per port 52V~56V DC (depending on the power supply), max. 36 watts Force <ul style="list-style-type: none"> - Per port 52V~56V DC (depending on the power supply), max. 60 watts
Power Pin Assignment	End-span: 1/2(-), 3/6(+) Mid-span: 4/5(+), 7/8(-) 802.3bt/UPoE: 1/2(-), 3/6(+), 4/5(+), 7/8(-)
PoE Power Budget	Single Power Input <ul style="list-style-type: none"> - 240-watt maximum(depending on power input) Dual Power Input <ul style="list-style-type: none"> - 360-watt maximum(depending on power input) ※ Dual power input must be the same as DC voltage, link dual 56V
PoE Ability PD @ 12.5 watts	8 units
PoE Ability PD @ 25 watts	8 units
PoE Ability PD @ 51 watts	6 units
PoE Ability PD @ 71 watts	4 units
PoE Management Functions	
Active PoE device alive detects	Yes
PoE Power Recycle	Yes, daily or predeinded schedule
PoE Schedule	4 schedule profiles
PoE Extend Mode	Yes, max. 160 to 200 meters
PoE System Management	System PoE Admin control Total PoE power budget control Auto power input and PoE budget control PoE Legacy mode Over-temperature threshold alarm PoE usage threshold alarm
PoE Port Management	Port Enable/Disable/Schedule PoE mode control <ul style="list-style-type: none"> - 802.3bt - UPoE - 802.3at End-span - 802.3at Mid-span Force mode Port Priority
Layer 2 Functions	

Port Configuration	Port disable/enable Auto-negotiation 10/100/1000Mbps full and half duplex mode selection Flow control disable/enable Port link capability control
Port Status	Display each port's speed duplex mode, link status, flow control status, auto negotiation status, trunk status
Port Mirroring	TX/RX/both Many-to-1 monitor
VLAN	802.1Q tagged VLAN Q-in-Q tunneling Private VLAN Edge (PVE) MAC-based VLAN Protocol-based VLAN Voice VLAN MVR (Multicast VLAN Registration) GVRP Up to 256 VLAN groups, out of 4095 VLAN IDs
Link Aggregation	IEEE 802.3ad LACP/static trunk Supports 3 trunk groups with 4 ports per trunk group
Spanning Tree Protocol	IEEE 802.1D Spanning Tree Protocol IEEE 802.1w Rapid Spanning Tree Protocol IEEE 802.1s Multiple Spanning Tree Protocol
IGMP Snooping	IPv4 IGMP (v1/v2/v3) snooping IPv4 IGMP querier mode support Supports 255 IGMP groups
MLD Snooping	IPv6 MLD (v1/v2) snooping, IPv6 MLD querier mode support Supports 255 MLD groups
Access Control List	IP-based ACL/MAC-based ACL ACL based on: <ul style="list-style-type: none"> - MAC Address - IP Address - Ethertype - Protocol Type - VLAN ID - DSCP - 802.1p Priority Up to 256 entries
Bandwidth Control	Per port bandwidth control Ingress: 500Kb~1000Mbps Egress: 500Kb~1000Mbps
QoS	Traffic classification based, strict priority and WRR 8-level priority for switching <ul style="list-style-type: none"> - Port number - 802.1p priority - 802.1Q VLAN tag - DSCP/TOS field in IP packet

Synchronization	IEEE 1588v2 PTP(Precision Time Protocol) - Peer-to-peer transparent clock - End-to-end transparent clock
Layer 3 Functions	
IP Interfaces	Max. 128 VLAN interfaces
Routing Table	Max. 128 routing entries
Routing Protocols	IPv4 hardware static routing IPv6 hardware static routing OSPFv2 dynamic routing
Management	
Basic Management Interfaces	Console; Telnet; Web browser; SNMP v1, v2c
Secure Management Interfaces	SSHv1/SSHv2, TLS v1.1/v1.2, SSL, SNMP v3
SNMP MIBs	RFC 1213 MIB-II RFC 1493 Bridge MIB RFC 1643 Ethernet MIB RFC 2863 Interface MIB RFC 2665 Ether-Like MIB RFC 2819 RMON MIB (Group 1, 2, 3 and 9) RFC 2737 Entity MIB RFC 2618 RADIUS Client MIB RFC 2863 IF-MIB RFC 2933 IGMP-STD-MIB RFC 3411 SNMP-Frameworks-MIB RFC 4292 IP Forward MIB RFC 4293 IP MIB RFC 4836 MAU-MIB IEEE 802.1X PAE LLDP
Standards Conformance	
Regulatory Compliance	FCC Part 15 Class A CE: EN55032 EN55035
Stability Testing	IEC 60068-2-32 (free fall) IEC 60068-2-27 (shock) IEC 60068-2-6 (vibration)
Standards Compliance	IEEE 802.3 10BASE-T IEEE 802.3u 100BASE-TX/100BASE-FX IEEE 802.3z Gigabit SX/LX IEEE 802.3ab Gigabit 1000T IEEE 802.3ae 10Gb/s Ethernet (IGS-6325-8UP2S2X) IEEE 802.3x flow control and back pressure IEEE 802.3ad port trunk with LACP IEEE 802.1D Spanning Tree Protocol

	<p>IEEE 802.1w Rapid Spanning Tree Protocol IEEE 802.1s Multiple Spanning Tree Protocol IEEE 802.1p Class of Service IEEE 802.1Q VLAN tagging IEEE 802.1X Port Authentication Network Control IEEE 802.1ab LLDP IEEE 802.3af Power over Ethernet IEEE 802.3at Power over Ethernet Plus IEEE 802.3bt Power over Ethernet Plus Plus IEEE 802.3ah OAM IEEE 802.1ag Connectivity Fault Management (CFM) RFC 768 UDP RFC 793 TFTP RFC 791 IP RFC 792 ICMP RFC 2068 HTTP RFC 1112 IGMP v1 RFC 2236 IGMP v2 RFC 3376 IGMP v3 RFC 2710 MLD v1 RFC 3810 MLD v2 RFC 2328 OSPF v2 ITU-T G.8032 ERPS Ring ITU-T Y.1731 Performance Monitoring</p>
Environment	
Operating Temperature	-40 ~ 75 degrees C
Storage Temperature	-40 ~ 85 degrees C
Humidity	5 ~ 95% (non-condensing)

3.3 PHYSICAL SPECIFICATIONS:

Dimensions:

76.8 x 107 x 152 mm (W x D x H)

Drawing:

■ IGS-6325-8UP2S

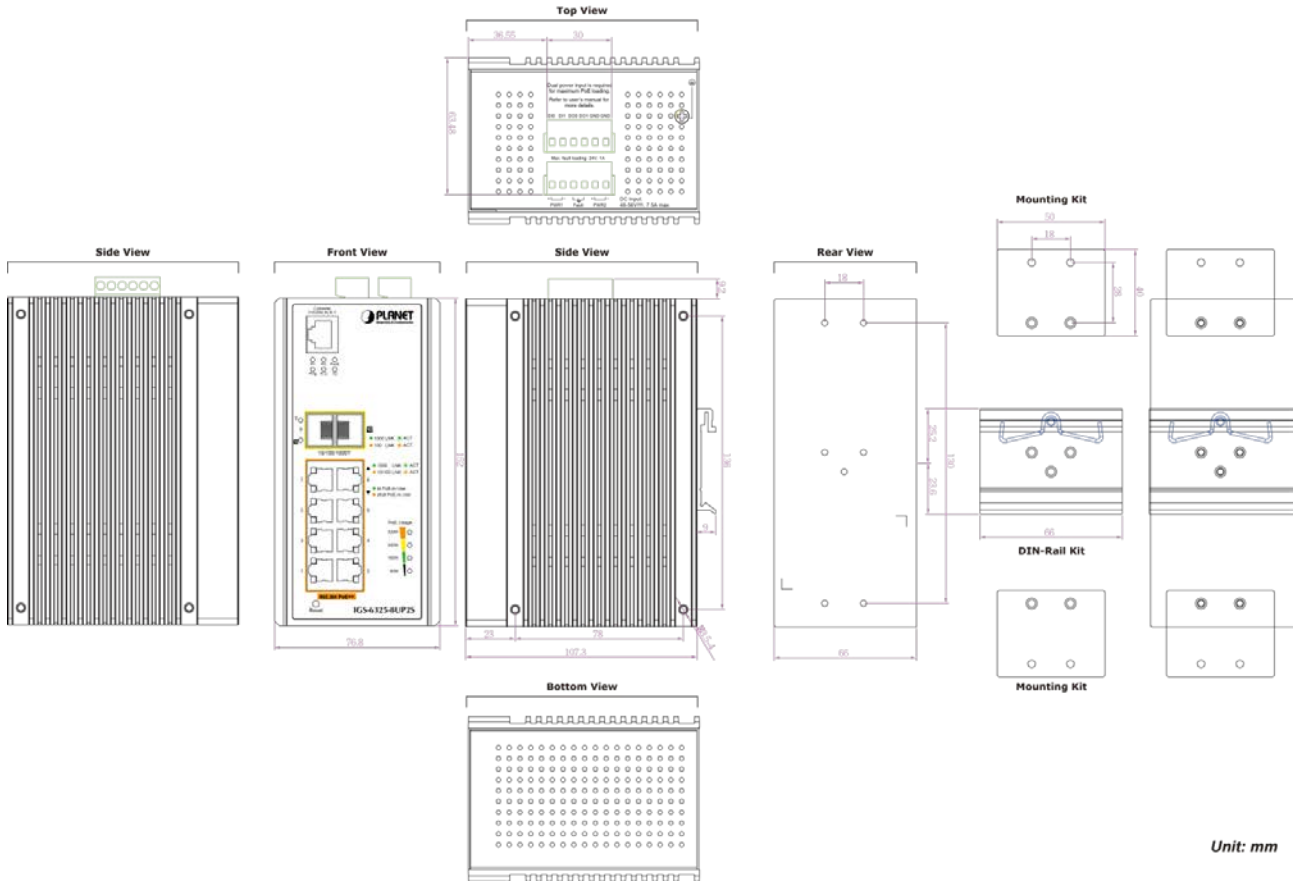

Unit: mm

IGS-6325-8UP2S2X

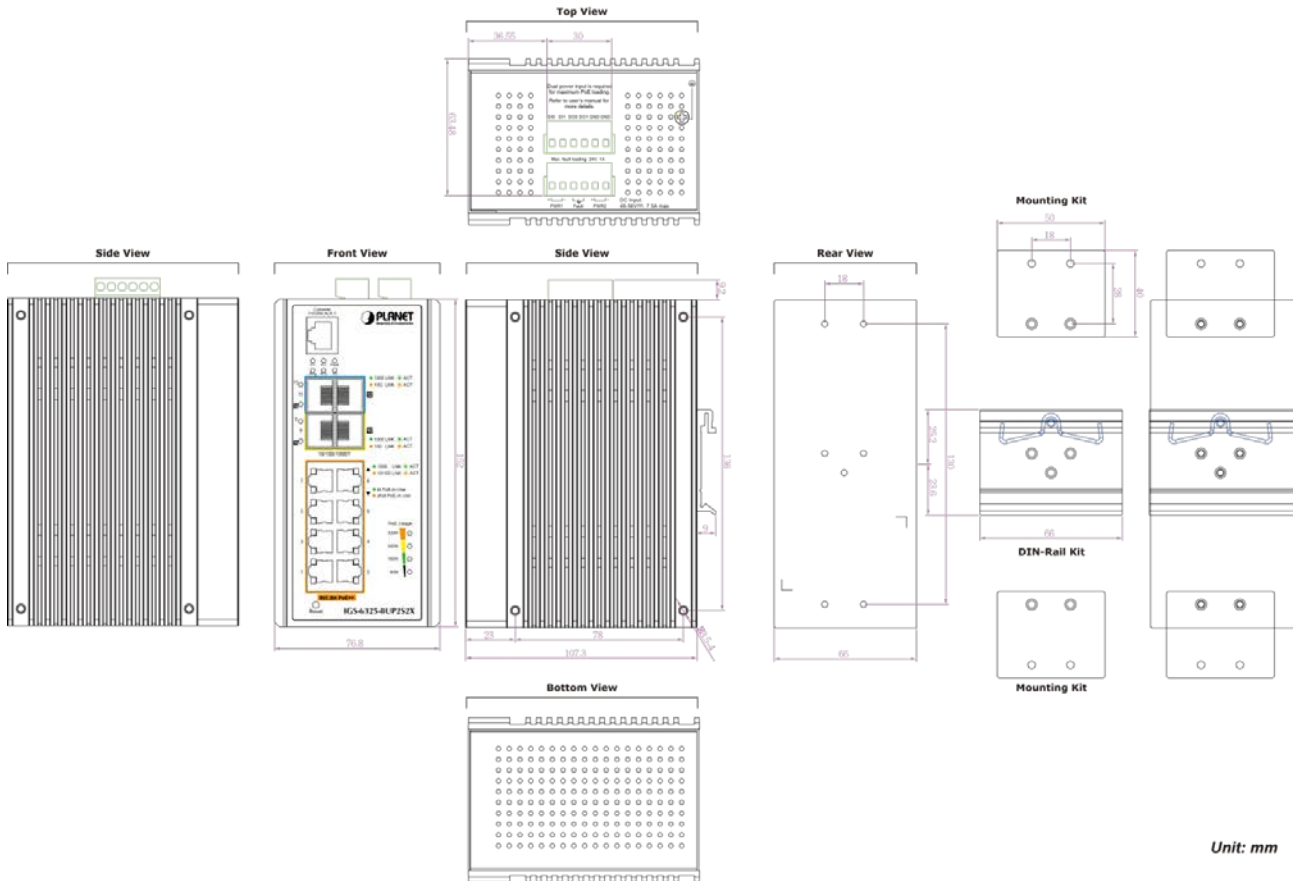

Unit: mm

Top View

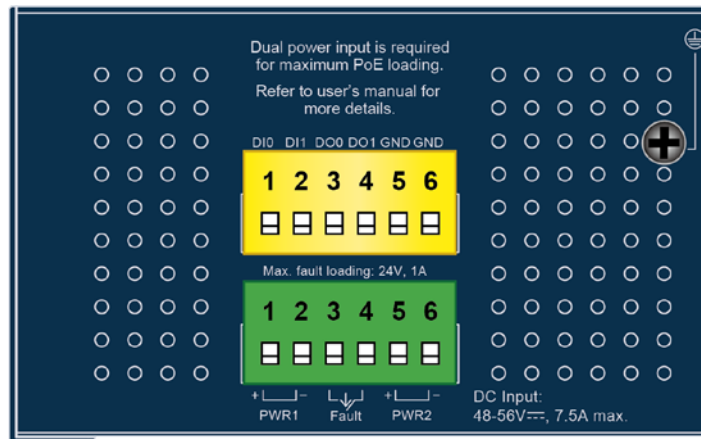

Front View

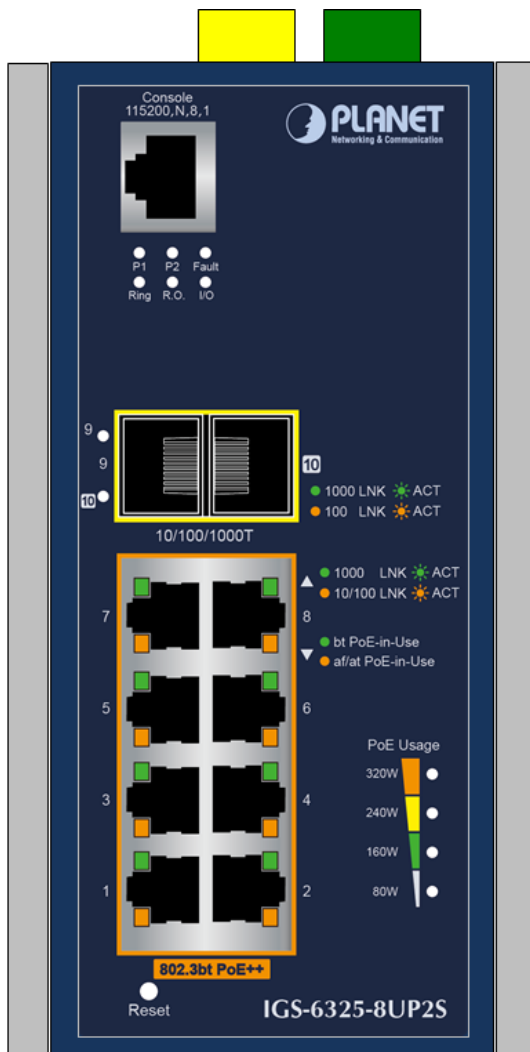

IGS-6325-8UP2S

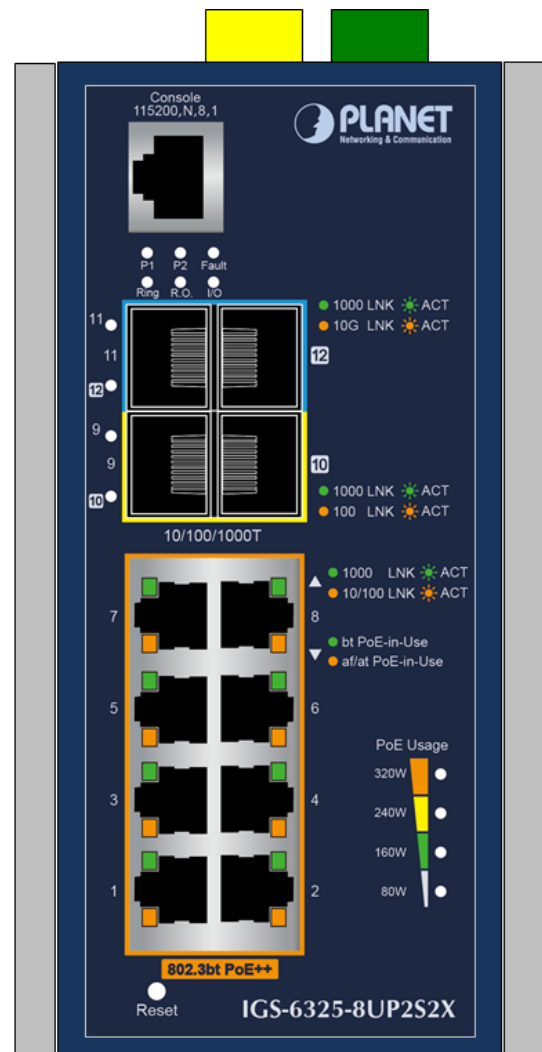

IGS-6325-8UP2S2X

LED Definition:

■ **System and Power**

LED	Color	Function	
R.O.*	Green	Lights to indicate that Switch has enabled Ring Owner.	
Ring	Green	Lights to indicate that the ERPS Ring has been created successfully.	
DIDO	Red	Blinks:	To indicate the DI and DO events
		Off:	No event
FAULT	Red	Lit:	To indicate there could be a power fault or port fault
		Off:	No failure
PWR2	Green	Lit:	Power 2 is activated.
		Off:	Power 2 is inactivated.
PWR1	Green	Lit:	Power 1 is activated.
		Off:	Power 1 is inactivated.

■ **Per 10/100/1000BASE-T, 802.3bt PoE++ RJ45 Port (Port-1 ~ Port-8)**



LED	Color	Function	
1000 LNK/ACT	Green	Lights:	To indicate the port is running at 1000Mbps speed and successfully established.
		Blinks:	To indicate that the switch is actively sending or receiving data over that port.
10/100 LNK/ACT	Amber	Lights:	To indicate the port is running at 10/100Mbps speed and successfully established.
		Blinks:	To indicate that the switch is actively sending or receiving data over that port.
PoE-in-Use	Green	Lights:	To indicate the PoE port is working in 4-pair PoE mode (end-span + mid-span) or Force mode and offers up to 95 watts of power.
	Amber	Lights:	To indicate the PoE port is working in 802.3at PoE+ mode – be it end-span or mid-span – and offers up to 36 watts of power.

■ Per 100/1000BASE-X SFP Interface



LED	Color	Function	
1000 LNK/ACT	Green	Lights:	To indicate the port is successfully established at 1000Mbps.
		Blinks:	To indicate that the Switch is actively sending or receiving data over that port.
100 LNK/ACT	Amber	Lights:	To indicate the port is successfully established at 100Mbps.
		Blinks:	To indicate that the Switch is actively sending or receiving data over that port.

■ Per 10GBASE-SR/LR SFP+ port (IGS-6325-8UP2S2X)

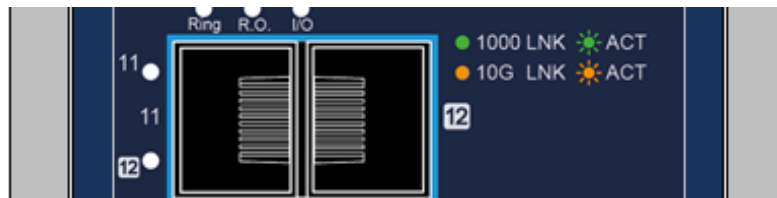

LED	Color	Function	
1000 LNK/ACT	Green	Lights:	To indicate the port is running at 1000Mbps speed.
		Blinks:	To indicate that the switch is actively sending or receiving data over that port.
10G LNK/ACT	Amber	Lights:	To indicate the port is running at 10Gbps speed and successfully established.

■ PoE Usage LED

LED	Color	Function	
80	Amber	Lights:	To indicate the system consumes over 80-watt PoE power budget
160	Amber	Lights:	To indicate the system consumes over 160-watt PoE power budget
240	Amber	Lights:	To indicate the system consumes over 240-watt PoE power budget
320	Amber	Lights:	To indicate the system consumes over 320-watt PoE power budget

■ **DI/DO connector:**

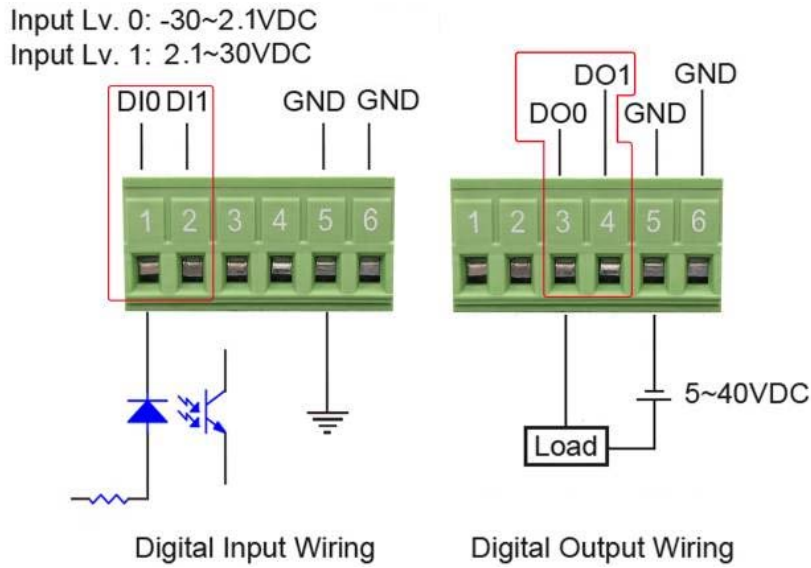

3.4 ENVIRONMENTAL SPECIFICATIONS

Operating:

- Temperature: -40 ~75 degrees C
- Relative Humidity: 5% ~ 95% (non-condensing)

Storage:

- Temperature: -40 ~85 degrees C
- Relative Humidity: 5% ~ 95% (non-condensing)

3.5 ELECTRICAL SPECIFICATIONS

Power Requirements:

DC 48~56V, redundant power with reverse polarity protection

Power Consumption:

LOADING	System on without any devices attached		Ethernet Full Loading (RJ45-SFP)	
	IGS-6325-8UP2S	IGS-6325-8UP2S2X	IGS-6325-8UP2S	IGS-6325-8UP2S2X
Power INPUT				
DC 52V	18W	19W	388W	392W
DC 56V	27W	29W	395W	401W

* The maximum full loading is tested with RJ45-to-SFP transceivers.

3.6 REGULATORY COMPLIANCE

FCC Part 15 Class A

CE:

- EN 55032
- EN 55035

Stability Testing:

- IEC 60068-2-32 (free fall)
- IEC 60068-2-27 (shock)
- IEC 60068-2-6 (vibration)

3.7 RELIABILITY

MTBF > 100,000hrs @ 25 degrees C

3.8 BASIC PACKAGING

Models	IGS-6325-8UP2S	IGS-6325-8UP2S2X
<input checked="" type="checkbox"/> The Industrial Managed Switch	x 1	x 1
<input checked="" type="checkbox"/> Quick Installation Guide	x 1	x 1
<input checked="" type="checkbox"/> RJ45-to-DB9 RS232 Cable	x 1	x 1
<input checked="" type="checkbox"/> DIN-rail Kit	x 1	x 1
<input checked="" type="checkbox"/> Wall Mounting Kit	x 1	x 1
<input checked="" type="checkbox"/> RJ45 Dust Cap	x 9	x 9
<input checked="" type="checkbox"/> SFP Dust Cap	x 2	x 4

3.9 PACKING INFORMATION

Models	IGS-6325-8UP2SX	IGS-6325-8UP2S
Box Dimensions (W x D x H):	300 x 170 x 90mm	
Gross Weight:	1.59kg	1.51kg
Carton Dimensions (W x D x H):	385 x 340 x 490 mm	
Total Weight:	16.3 kg	16.1 kg
Quantity:	10pcs in one carton	

APPENDIX A – Relay alarm definition

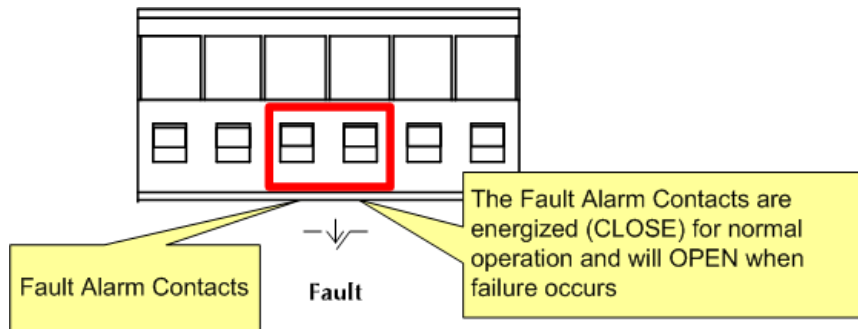

	Fault Alarm Configured			No Power/Not Configured			
Power Input	<input checked="" type="checkbox"/> P1 <input checked="" type="checkbox"/> P2	<input checked="" type="checkbox"/> P1 <input type="checkbox"/> P2	<input type="checkbox"/> P1 <input checked="" type="checkbox"/> P2	<input type="checkbox"/> P1 <input type="checkbox"/> P2	<input checked="" type="checkbox"/> P1 <input checked="" type="checkbox"/> P2	<input checked="" type="checkbox"/> P1 <input type="checkbox"/> P2	<input type="checkbox"/> P1 <input checked="" type="checkbox"/> P2
Relay Alarm	short	open	open	short	open	short	short
Fault LED	OFF	ON	ON	OFF	OFF	OFF	OFF

APPENDIX B RESET BUTTON Definition

Reset Button Pressed and Released	Function
< 5 sec: System Reboot	Reboot the Managed Switch.
> 5 sec: Factory Default	Reset the Managed Switch to Factory Default configuration. The Managed Switch will then reboot and load the default settings as shown below: <ul style="list-style-type: none"> ◦ Default Username: admin ◦ Default Password: admin ◦ Default IP Address: 192.168.0.100 ◦ Subnet Mask: 255.255.255.0 ◦ Default Gateway: 192.168.0.254